

User Manual

Version 1.1 June 2011

Touchscreen PC 15 Hardware System TPC 15

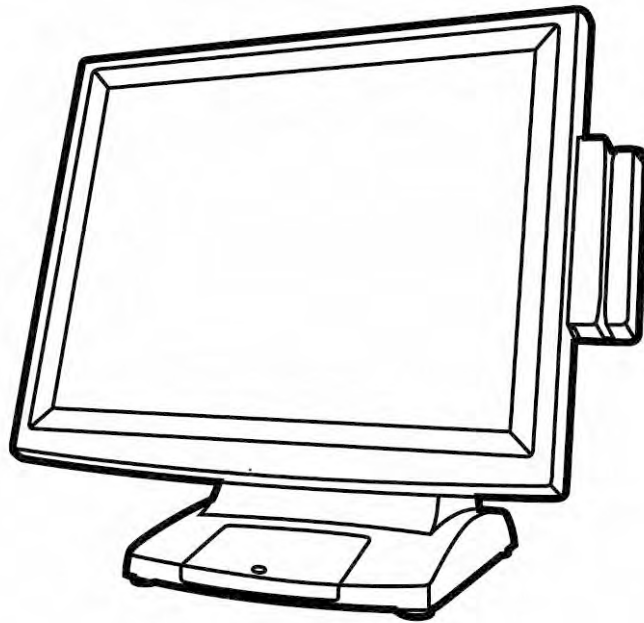

Copyright 2011
All Rights Reserved
Manual Version 1.1
Part Number: 3LMPP3350311

The information contained in this document is subject to change without notice.

We make no warranty of any kind with regard to this material, including, but not limited to, the implied warranties of merchantability and fitness for a particular purpose. We shall not be liable for errors contained herein or for incidental or consequential damages in connection with the furnishing, performance, or use of this material.

This document contains proprietary information that is protected by copyright. All rights are reserved. No part of this document may be photocopied, reproduced or translated to another language without the prior written consent of the manufacturer.

TRADEMARK

Intel®, Pentium® and MMX are registered trademarks of Intel® Corporation. Microsoft® and Windows® are registered trademarks of Microsoft Corporation.

Other trademarks mentioned herein are the property of their respective owners.

Safety

IMPORTANT SAFETY INSTRUCTIONS

1. To disconnect the machine from the electrical Power Supply, turn off the power switch and remove the power cord plug from the wall socket. The wall socket must be easily accessible and in close proximity to the machine.
2. Read these instructions carefully. Save these instructions for future reference.
3. Follow all warnings and instructions marked on the product.
4. Do not use this product near water.
5. Do not place this product on an unstable cart, stand, or table. The product may fall, causing serious damage to the product.
6. Slots and openings in the cabinet and the back or bottom are provided for ventilation; to ensure reliable operation of the product and to protect it from overheating. These openings must not be blocked or covered. The openings should never be blocked by placing the product on a bed, sofa, rug, or other similar surface. This product should never be placed near or over a radiator or heat register, or in a built-in installation unless proper ventilation is provided.
7. This product should be operated from the type of power indicated on the marking label. If you are not sure of the type of power available, consult your dealer or local power company.
8. Do not allow anything to rest on the power cord. Do not locate this product where persons will walk on the cord.
9. Never push objects of any kind into this product through cabinet slots as they may touch dangerous voltage points or short out parts that could result in a fire or electric shock. Never spill liquid of any kind on the product.

CE MARK



This device complies with the requirements of the EEC directive 2004/108/EC with regard to “Electromagnetic compatibility” and 2006/95/EC “Low Voltage Directive”

FCC

This device complies with part 15 of the FCC rules. Operation is subject to the following two conditions:

- (1) This device may not cause harmful interference.
- (2) This device must accept any interference received, including interference that may cause undesired operation

CAUTION ON LITHIUM BATTERIES

There is a danger of explosion if the battery is replaced incorrectly. Replace only with the same or equivalent type recommended by the manufacturer. Discard used batteries according to the manufacturer's instructions.



Battery Caution

Risk of explosion if battery is replaced by an incorrectly type.
Dispose of used battery according to the local disposal instructions.



Safety Caution

Note: To comply with IEC60950-1 Clause 2.5 (limited power sources, L.P.S) related legislation, peripherals shall be 4.7.3.2 "Materials for fire enclosure" compliant.

4.7.3.2 Materials for fire enclosures

For MOVABLE EQUIPMENT having a total mass not exceeding 18kg.the material of a FIRE ENCLOSURE, in the thinnest significant wall thickness used, shall be of V-1 CLASS MATERIAL or shall pass the test of Clause A.2.

For MOVABLE EQUIPMENT having a total mass exceeding 18kg and for all STATIONARY EQUIPMENT, the material of a FIRE ENCLOSURE, in the thinnest significant wall thickness used, shall be of 5VB CLASS MATERIAL or shall pass the test of Clause A.1

LEGISLATION AND WEEE SYMBOL

2002/96/EC Waste Electrical and Electronic Equipment Directive on the treatment, collection, recycling and disposal of electric and electronic devices and their components.

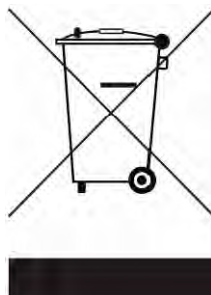

The crossed dustbin symbol on the device means that it should not be disposed of with other household wastes at the end of its working life. Instead, the device should be taken to the waste collection centers for activation of the treatment, collection, recycling and disposal procedure.

To prevent possible harm to the environment or human health from uncontrolled waste disposal, please separate this from other types of wastes and recycle it responsibly to promote the sustainable reuse of material resources.

Household users should contact either the retailer where they purchased this product, or their local government office, for details of where and how they can take this item for environmentally safe recycling.

Business users should contact their supplier and check the terms and conditions of the purchase contract.

This product should not be mixed with other commercial wastes for disposal.

Revision History

Changes to the original user manual are listed below:

Revision	Date	Description
V1.0	Sep, 2009	● Release
V1.1	June, 2011	● C46 MB added

Table Contents

1 Item Checklist.....	1
1-1 Standard Items	1
1-2 Optional Items	2
2 System View	3
2-1 Front View	3
2-2 Rear View.....	4
2-3 Bottom View	5
2-4 I/O View.....	6
3 Peripheral Installation.....	7
3-1 MSR & Fingerprint.....	7
3-2 VFD	8
3-3 Second Display	10
3-4 Cash Drawer	12
3-5 Wall Mount Kit	14
4 System Assembly & Disassembly.....	15
4-1 Replace the HDD	15
4-2 Replace the Power Adapter.....	16
4-3 Remove the System Stand.....	16
4-4 Remove the LCD Rear Cover & the System Box	17
4-5 Replace the Motherboard.....	18
4-6 Replace the Inverter Board	18
4-7 Replace the ELO Touch Control Board	19
4-8 Replace the LCD Panel.....	20
5 Specification	21

6 Jumper Settings 23

6-1 C36A Motherboard 23

Appendix 28

1 Item Checklist

Take the system unit out of the carton. Remove the unit from the carton by holding it by the foam inserts. The following contents should be found in the carton:

1-1 Standard Items

a.



b.



c.



d.

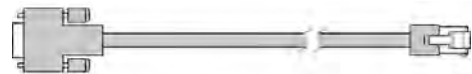

e.

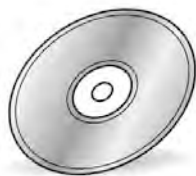

- a. System
- b. Power adapter (65W)
- c. Power cable
- d. COM-RJ45 cable (x2)
- e. Driver CD

1-2 Optional Items

a.



b.

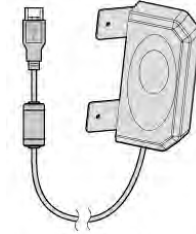

c.



d.

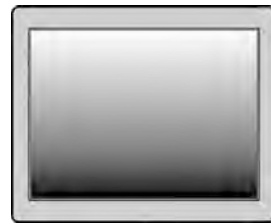

e.

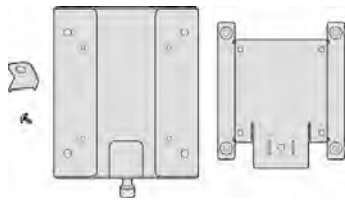

f.

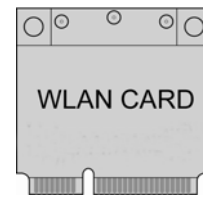

g.

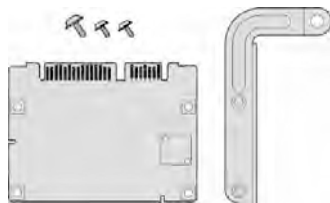

- a. MSR module
- b. Fingerprint
- c. VFD module
- d. Second display
- e. Wall mount kit
- f. Wireless LAN card
- g. pSSD card module

2 System View

2-1 Front View



Number	Description
1	Touch Screen
2	MSR Module (Option)
3	Power Button
4	Hard Disk Drive Cover

2-2 Rear View

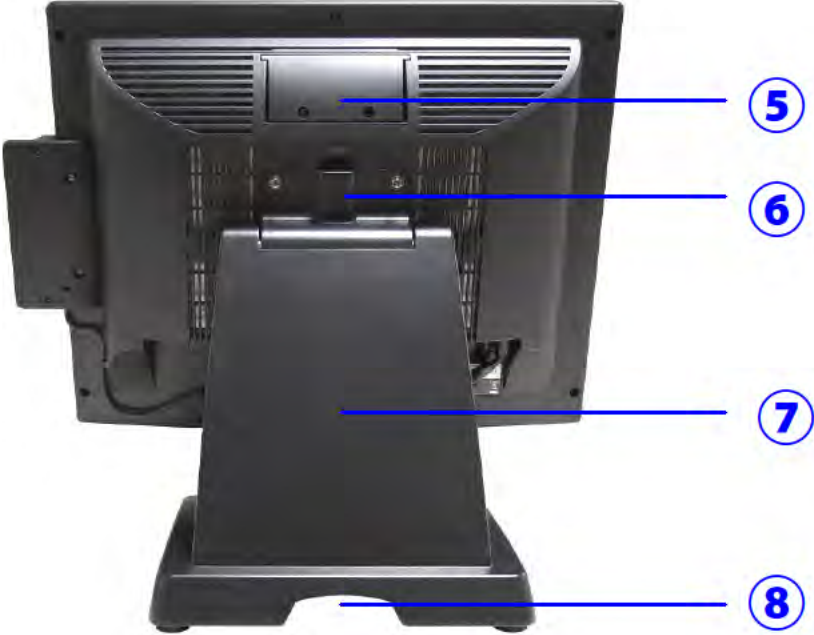

Number	Description
5	VFD cover (for VFD & Second display installation)
6	Stand/Wall mount kit installing place
7	Stand
8	Cable management outlet

2-3 Bottom View



Number	Description
9	Stand Pad
10	Easy-Service Retaining Bracket for Power Adapter

2-4 I/O View

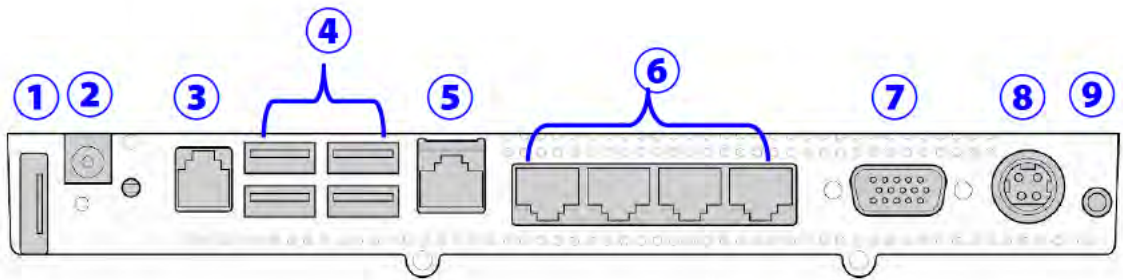

Number	Description
1	E-SATA connector
2	Power Jack for HDD
3	Cash Drawer
4	USB x 4
5	LAN
6	COM1~4 (from left to right)
7	VGA
8	Power Jack for System
9	Power Button

Note: The maximum current that can be drawn from each COM port is 500 mA.

3 Peripheral Installation

The peripheral and modules units provided are tested and can be supplied at your request.

3-1 MSR & Fingerprint

Components of MSR Kit:

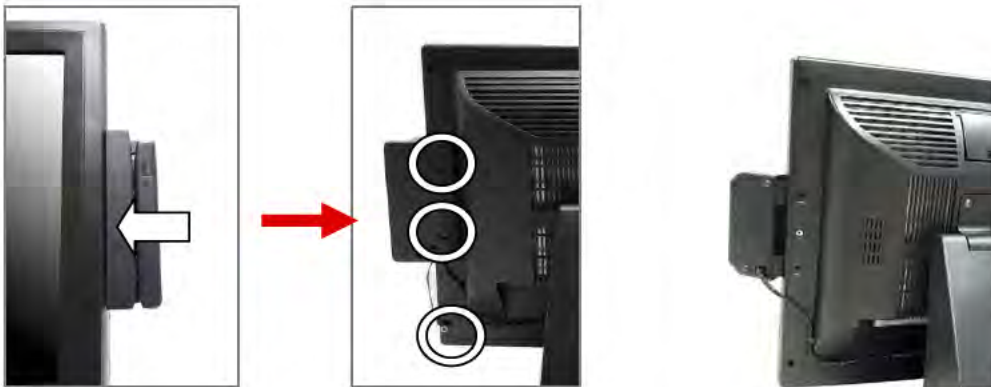

1. Slide the MSR into the right position of the System.
 2. Fasten the screws (x2) and grounding cable (x1).
- * The fingerprint scanner can be installed in the same way.

3-2 VFD

Components of VFD Kit:

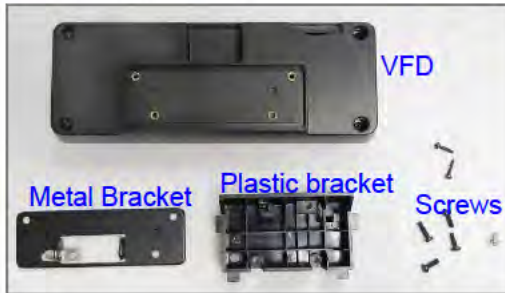

1. Remove the screws (x2) and slide the VFD Cover outward.



2. Positioning the VFD metal bracket onto the rear side of the VFD module and fasten the screws (x2).
3. Positioning the plastic bracket onto the metal bracket as the direction and steps of arrows show.



4. Fasten the screw (x1) to fix the plastic bracket to the metal bracket and VFD module.
5. Slide the MSR module with bracket into the VFD socket.
6. Fix the MSR module by fasten the screws (x2) as circles show.



7. Connect the VFD cable to the VFD Module.



8. Connect to the COM4 port of the System.

3-3 Second Display

To install the Second Display, please open the VFD cover first (Chapter 3-2-1).

Components of Second Display Kit with power adapter:

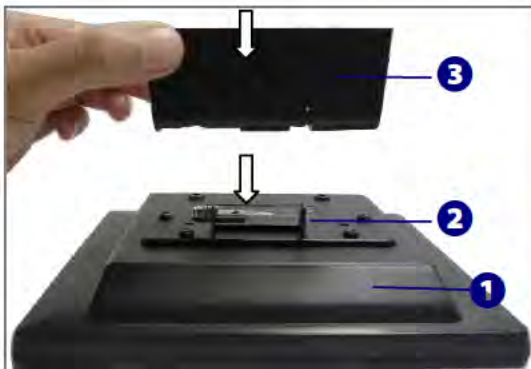
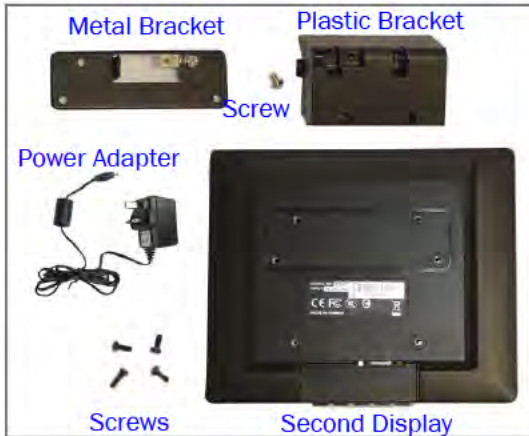

Fix the parts of Second Display modules as steps **1** → **2** → **3**

1. as above left picture shows. (detail steps as below)

- 1** Put the second display upside down.
- 2** Place the metal bracket onto the rear side of the second display and fasten the screws (x4) to fix metal bracket with the system.
- 3** Align the plastic bracket into the right position of metal bracket.
 - (a) Align the plastic bracket onto the metal bracket.
 - (b) Push to left until the click sound appears.



2. Fasten the screw (x1) to fix the plastic bracket and Second Display module with metal bracket.
3. Slide the Second Display Module into the slot.



4. Fasten the screws (x2) to fix the Second Display module with the System.
5. Connect the VGA cable to the Second Display Module and the System.



6. Finish.

3-4 Cash Drawer

You can install a cash drawer through the cash drawer port. Please verify the pin assignment before installation.

Cash Drawer Pin Assignment

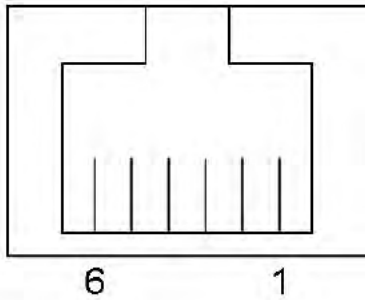

Pin	Signal
1	GND
2	DOUT bit0
3	DIN bit0
4	12V / 19V
5	DOUT bit1
6	GND

Cash Drawer Controller Register

The Cash Drawer Controller use one I/O addresses to control the Cash Drawer.

Register Location: 48Ch

Attribute: Read / Write

Size: 8bit

BIT	BIT7	BIT6	BIT5	BIT4	BIT3	BIT2	BIT1	BIT0
Attribute	Reserved	Read	Reserved	Reserved	Write	Reserved	Reserved	Reserved

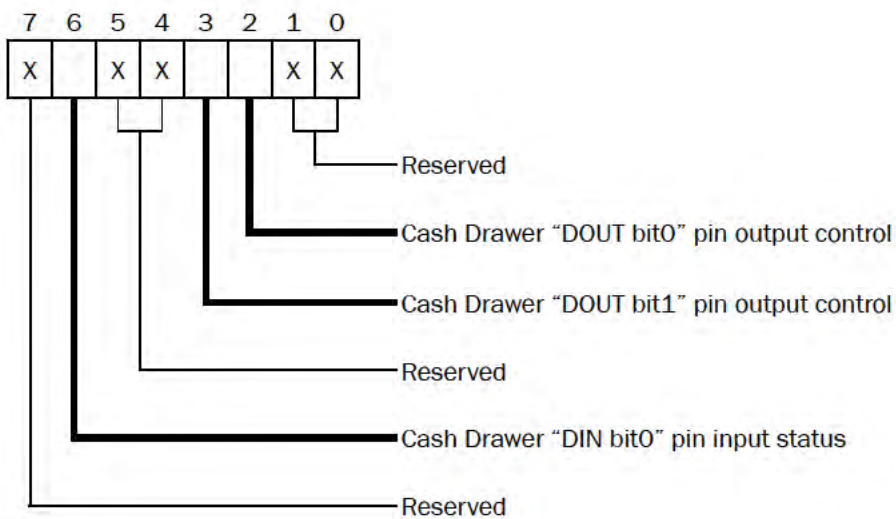

Bit 7: Reserved

Bit 6: Cash Drawer "DIN bit0" pin input status.

= 1: the Cash Drawer closed or no Cash Drawer

= 0: the Cash Drawer opened

Bit 5: Reserved

Bit 4: Reserved

Bit 3: Cash Drawer "DOUT bit1" pin output control.

= 1: Opening the Cash Drawer

= 0: Allow close the Cash Drawer

Bit 2: Cash Drawer "DOUT bit0" pin output control.

= 1: Opening the Cash Drawer

= 0: Allow close the Cash Drawer

Bit 1: Reserved

Bit 0: Reserved

Note: Please follow the Cash Drawer control signal design to control the Cash Drawer.

Cash Drawer Control Command Example

Use Debug.EXE program under DOS or Windows98

Command	Cash Drawer
O 48C 04	Opening
O 48C 00	Allow to close
<p>➤ Set the I/O address 48Ch bit2 =1 for opening Cash Drawer by "DOUT bit0" pin control.</p> <p>➤ Set the I/O address 48Ch bit2 = 0 for allow close Cash Drawer.</p>	

Command	Cash Drawer
I 48C	Check status
<p>➤ The I/O address 48Ch bit6 =1 mean the Cash Drawer is opened or not exist.</p> <p>➤ The I/O address 48Ch bit6 =0 mean the Cash Drawer is closed.</p>	

3-5 Wall Mount Kit

Before installing the Wall Mount Kit, please remove the stand first if needed. (See Chapter 4-3 for removing the stand)

(Parts of Wall Mount Kit)

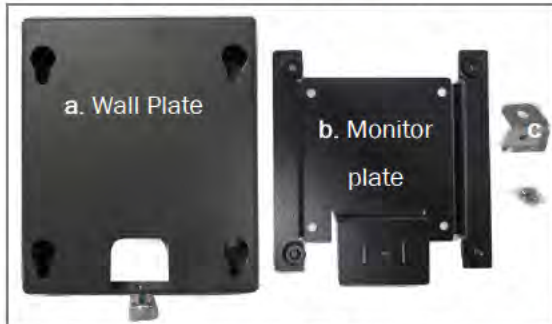

(Place to install)



1. Components of VESA-standard wall mount kit includes follows.
 - a. Wall-mounting plate
 - b. Monitor-mounting plate & screws
 - c. Screw metal bracket
2. The wall mount Kit installing place is at the rear side of the system.

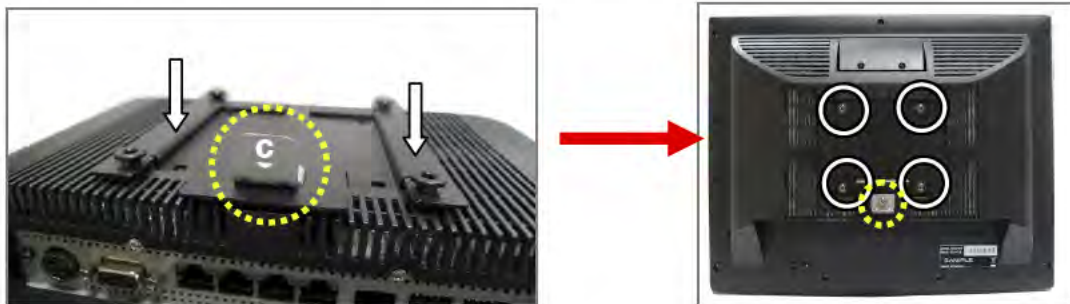

3. Place "b" which has 4 fixed hooks onto the rear side of the LCD rear cover.
4. Place "c" onto the hole of the monitor plate as the position as picture shows and fasten the screw (x1).
5. Fasten the screws (x4) to fix the monitor plate.



6. Fix "a" on the wall at your request.
7. Fasten the thumb screw (x1).
8. Align the hooks of "monitor plate" into the keyholes of the "wall plate".

4 System Assembly & Disassembly

4-1 Replace the HDD



1. Unfasten the screw (x1).
2. Slide out the HDD Cover.



3. Unfasten the screws (x4)
4. Separate the HDD from the metal bracket.

4-2 Replace the Power Adapter



1. Release the thumb screw to separate the retaining metal bracket from the stand and take out the power adapter.

4-3 Remove the System Stand



1. Release the screws (x2) that fasten the stand and the system.
2. Release the screws (x4) that fasten the plastic VESA mounting plate and the LCD rear cover.



3. Remove the VESA metal bracket,.

4-4 Remove the LCD Rear Cover & the System Box

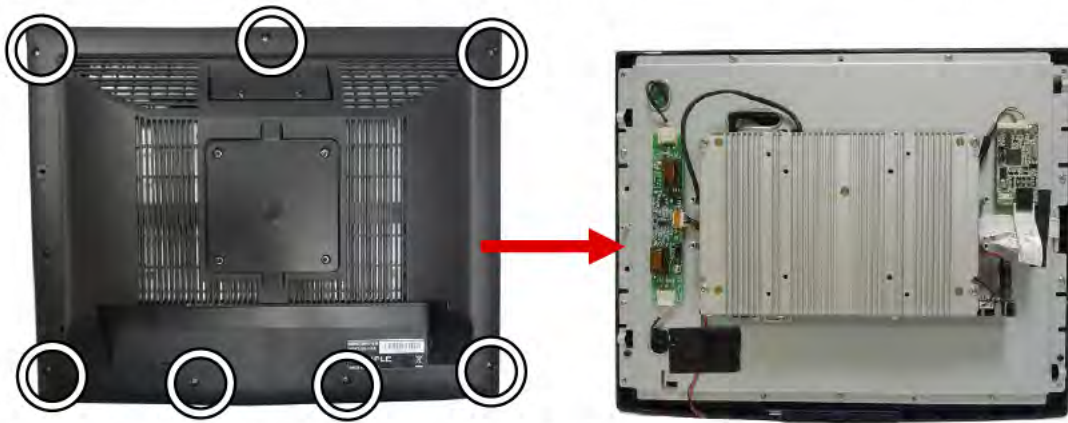

1. Remove the system stand (Chapter 4-3).
2. Unfasten the screws (x7) to separate the LCD Rear Cover.
3. After remove the LCD Rear Cover, you will see the “system box” inside.
Inside of the system box is the motherboard place.

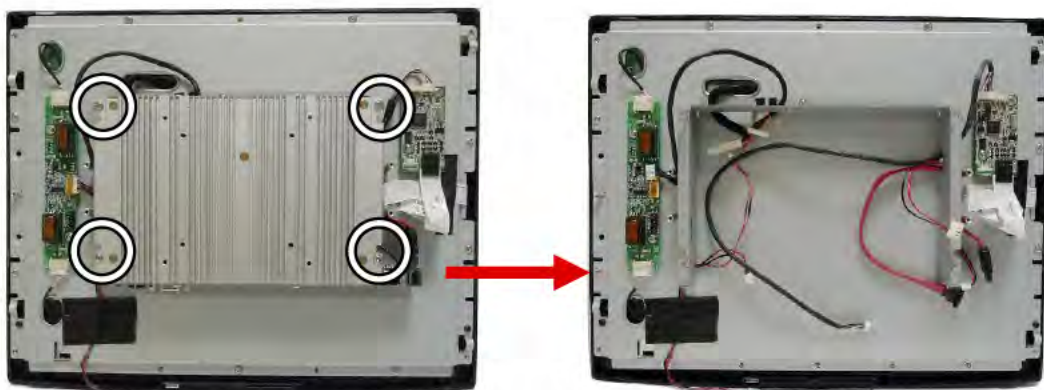

4. Unfasten the scrws (x4) at both sides of the system box to uncover the Motherboard.
5. **Gently** flip up the system box.
Note: Please release all the connectors on the Motherboard before you completely open the system box.

4-5 Replace the Motherboard



1. To open the LCD rear cover & system box first as steps in Chapter 4-4.
2. Unfasten the screws (x5) on the Motherboard.
3. Unfasten the hex screws (x2) to release the I/O metal panel from the Motherboard.

4-6 Replace the Inverter Board



1. To open the LCD rear cover first (see Chapter 4-4).
2. Unfasten the screws (x2).
3. Release the backlight connectors (x2).

4-7 Replace the ELO Touch Control Board

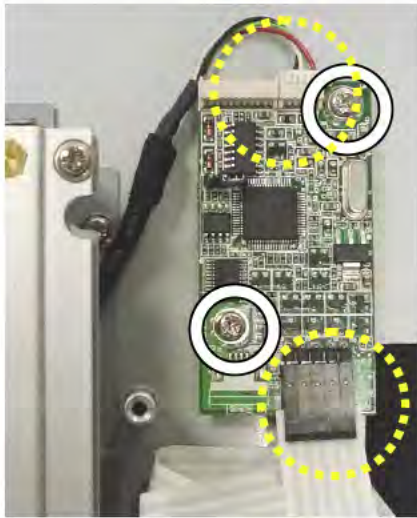

1. Open the LCD rear cover first (see Chapter 4-4).
2. Unfasten the screws (x2).
3. Release the connectors (x2).

4-8 Replace the LCD Panel

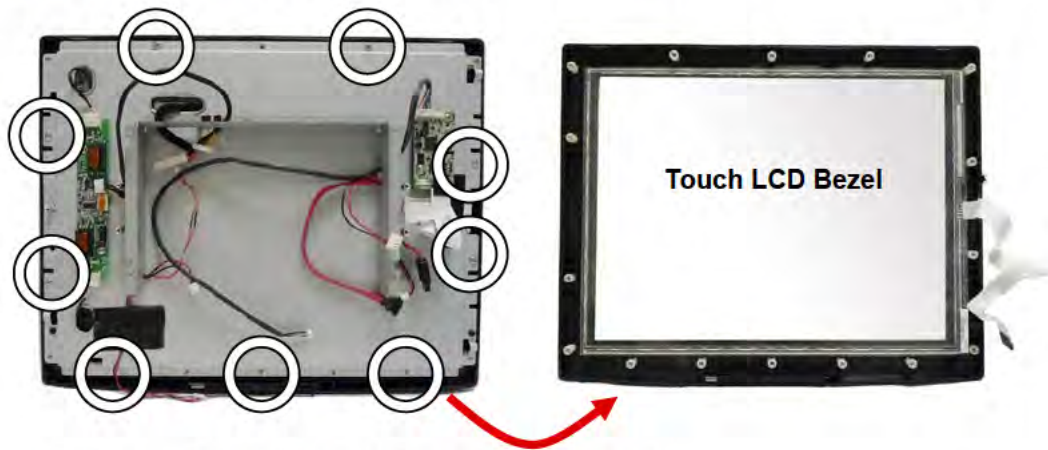

1. Remove the LCD rear Cover (Chapter 4-4)
2. Remove the system box and release all the connectors on the Motherboard (Chapter 4-4)
3. Release inverter cables & touch cables (Chapter 4-6 and 4-7)
4. Remove the screws (x9) to separate the Touch LCD bezel from the LCD Panel Module.



5. Release the screws (x4) that fix the sheet metal bracket to separate it from the LCD Panel.

5 Specification

Model Name	TPC 15
Motherboard	C36
CPU Support	Intel Atom N270 processors 1.6G, L2 512K FSB 533MHz
Chipset	Intel 945GSE Express chipset + ICH7M
System Memory	1 x DDR2 SO-DIMM socket up to 2GB
Graphic Memory	Intel GMA 950 share system memory up to 224MB
LCD Touch Panel	
LCD Size	15" TFT LCD
Brightness	250nits
Maximal Resolution	1024 x 768
Touch Screen Type	Resistive
Tilt Angle	4° ~ 84°
Storage	
HDD	One 2.5" SATA HDD bay
Flash Memory	SATA pSSD flash card (Option)
Expansion	
PCI-E Socket	1
External I/O Ports	
USB	4 ports (V2.0)
Serial / COM	4 x RJ-45 COM connectors (COM1 & COM2 standard RS-232; COM3 & COM4 pin10 with 5V /12V power by jumper)
LAN (10 /100 / 1000)	1 x RJ45
DC Jack	1
E-SATA interface	DC-OUT, E-SATA
2nd VGA	1
Cash Drawer Port	1 (19V)
Audio	
Speaker	2 x 2W speakers (Option)

Power	
Power Adapter	65W, 19V/3.4A
Control / Indicator	
Power Button	1
Indicator LED	1
Peripheral	
MSR module	MSR (USB)
Fingerprint	Fingerprint (USB)
Customer display	2 x 20 VFD customer display (COM)
Second display	8.4" 2nd display without touch
Communication	
Wireless LAN	802.11 b/g/n wireless LAN card & antenna (Option)
Environment	
EMC & Safety	FCC/CE Class A, LVD
Operating Temperature	5°C ~ 35°C (41°F ~ 104°F)
Storage Temperature	-20°C ~ 55°C (-4°F ~ 131°F)
Operating Humidity	20% ~ 80% RH non condensing
Storage Humidity	20% ~ 85% RH non condensing
Dimension	LCD 4 degree : 365.2 x 296.2 x 282.2 mm
(W x D x H)	LCD 84 degree : 365.2 x 217.76 x 343.1 mm
Weight (N.W./G.W.)	5.8kgs / 6.8kgs
Mounting	100mm x100mm VESA Standard holes
OS Support	Windows® XP Professional, Windows Embedded, POSReady 2009, Windows XP Embedded, Windows XP Professional for Embedded, WinCE, Windows 7, Linux

* This specification is subject to change without prior notice.

6 Jumper Settings

6-1 C36A Motherboard

6-1-1 Motherboard Layout

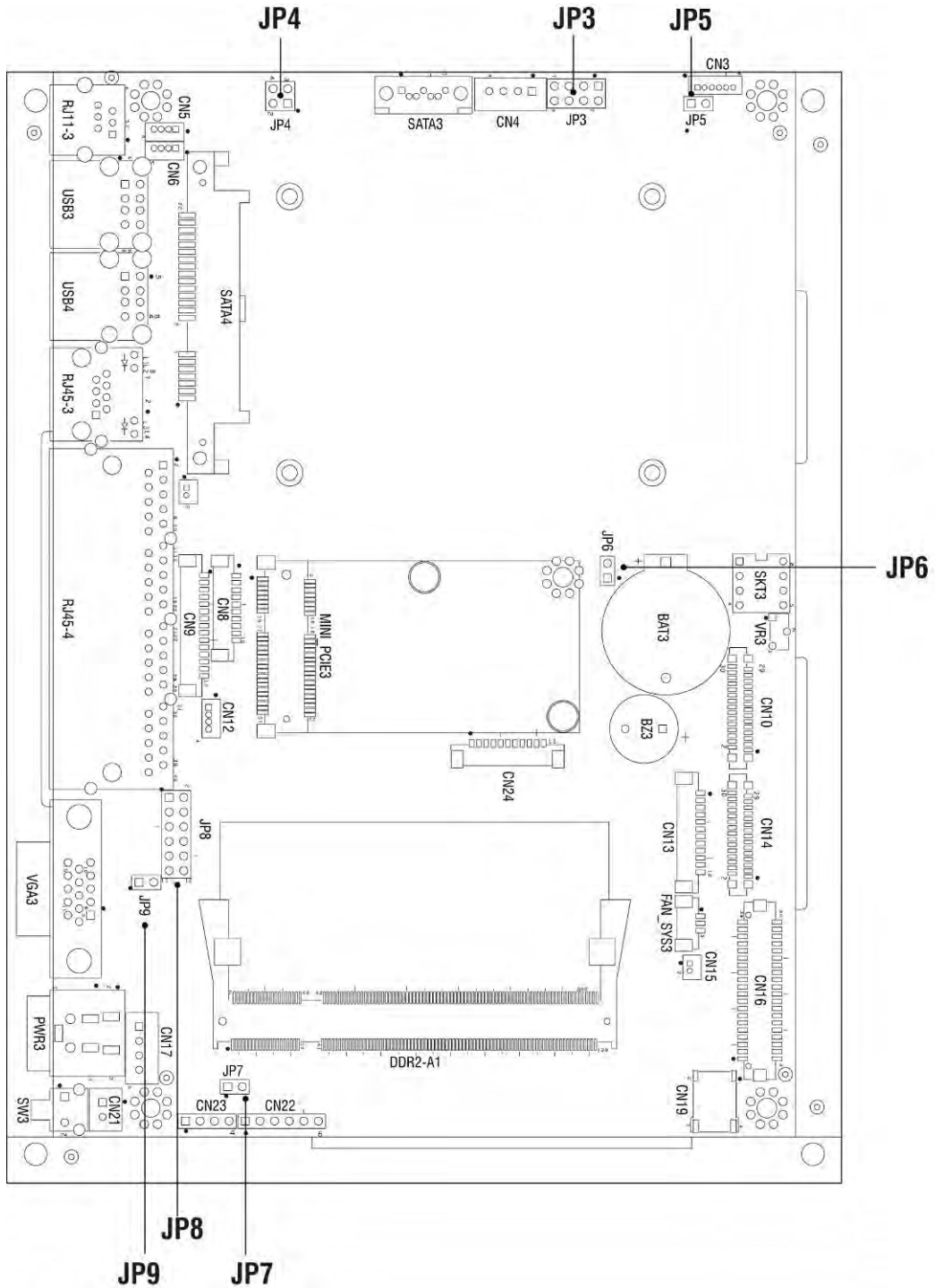

6-1-2 Connectors & Functions

Connector	Purpose
BAT3	CMOS Battery Base (Use CR2023)
CN3	Speaker & MIC Connector
CN4	Power Connector For HDD
CN5	USB5
CN6	USB7
CN9	Card Reader Connector
CN12	IrDA Connector
CN13	Inverter Connector
CN15	Power LED
CN16	LCD Interface Connector
CN21	Internal Power On Switch Connector
CN22	5 Wire Touch
CN24	FT Status Interface
DDR2_A1	DDR2 SO-DIMM
PWR3	+19V Power Adaptor
RJ11_3	Cash Drawer Connector
RJ45_3	LAN (On Board)
RJ45_4	COM1, COM2, COM3, COM4
FAN_SYS3	System FAN Connector
MINI_PCIE3	Mini PCI-E Socket
SATA3	SATA Connector
SKT3	SPI ROM
SW3	Power On Button
USB3	USB1, USB2
USB4	USB3, USB4
VGA3	VGA Port

6-1-3 Jumper Settings

Cash Drawer Power Settings

Function	JP4 (1-2) (3-4)								
+12V	<table style="border-collapse: collapse; margin: auto;"> <tr> <td style="padding: 0 5px;">1</td> <td style="padding: 0 5px;">3</td> </tr> <tr> <td style="text-align: center;">■</td> <td style="text-align: center;">□</td> </tr> <tr> <td style="text-align: center;">■</td> <td style="text-align: center;">□</td> </tr> <tr> <td style="padding: 0 5px;">2</td> <td style="padding: 0 5px;">4</td> </tr> </table>	1	3	■	□	■	□	2	4
1	3								
■	□								
■	□								
2	4								
▲ +19V	<table style="border-collapse: collapse; margin: auto;"> <tr> <td style="padding: 0 5px;">1</td> <td style="padding: 0 5px;">3</td> </tr> <tr> <td style="text-align: center;">□</td> <td style="text-align: center;">■</td> </tr> <tr> <td style="text-align: center;">□</td> <td style="text-align: center;">■</td> </tr> <tr> <td style="padding: 0 5px;">2</td> <td style="padding: 0 5px;">4</td> </tr> </table>	1	3	□	■	□	■	2	4
1	3								
□	■								
□	■								
2	4								

Power Mode Settings

Function	JP5 (1-2)		
▲ ATX Power	<table style="border-collapse: collapse;"> <tr> <td style="text-align: center;">□</td> </tr> <tr> <td style="text-align: center;">□</td> </tr> </table>	□	□
□			
□			
AT Power	<table style="border-collapse: collapse;"> <tr> <td style="text-align: center;">■</td> </tr> <tr> <td style="text-align: center;">■</td> </tr> </table>	■	■
■			
■			

CMOS Operation Mode

Function	JP6 (1-2)		
▲ CMOS Normal	<table style="border-collapse: collapse;"> <tr> <td style="text-align: center;">□</td> </tr> <tr> <td style="text-align: center;">□</td> </tr> </table>	□	□
□			
□			
CMOS Reset	<table style="border-collapse: collapse;"> <tr> <td style="text-align: center;">■</td> </tr> <tr> <td style="text-align: center;">■</td> </tr> </table>	■	■
■			
■			

System Reset Settings:

Function	JP7 (1-2)		
▲ Normal	<table style="border-collapse: collapse;"> <tr> <td style="text-align: center;">□</td> </tr> <tr> <td style="text-align: center;">□</td> </tr> </table>	□	□
□			
□			
Reset	<table style="border-collapse: collapse;"> <tr> <td style="text-align: center;">■</td> </tr> <tr> <td style="text-align: center;">■</td> </tr> </table>	■	■
■			
■			

▲ = Manufacturer Default Setting



OPEN



SHORT

COM3 & COM4 Power Settings

Function		JP8 (1-2) (3-4) (5-6) (7-8) (9-10) (11-12)																								
COM3 Pin10	RI	<table border="1"> <tr><td>1</td><td>3</td><td>5</td><td>7</td><td>9</td><td>11</td></tr> <tr><td>■</td><td>□</td><td>□</td><td>□</td><td>□</td><td>□</td></tr> <tr><td>■</td><td>□</td><td>□</td><td>□</td><td>□</td><td>□</td></tr> <tr><td>2</td><td>4</td><td>6</td><td>8</td><td>10</td><td>12</td></tr> </table>	1	3	5	7	9	11	■	□	□	□	□	□	■	□	□	□	□	□	2	4	6	8	10	12
	1	3	5	7	9	11																				
	■	□	□	□	□	□																				
■	□	□	□	□	□																					
2	4	6	8	10	12																					
▲+5V	<table border="1"> <tr><td>1</td><td>3</td><td>5</td><td>7</td><td>9</td><td>11</td></tr> <tr><td>□</td><td>■</td><td>□</td><td>□</td><td>□</td><td>□</td></tr> <tr><td>□</td><td>■</td><td>□</td><td>□</td><td>□</td><td>□</td></tr> <tr><td>2</td><td>4</td><td>6</td><td>8</td><td>10</td><td>12</td></tr> </table>	1	3	5	7	9	11	□	■	□	□	□	□	□	■	□	□	□	□	2	4	6	8	10	12	
1	3	5	7	9	11																					
□	■	□	□	□	□																					
□	■	□	□	□	□																					
2	4	6	8	10	12																					
+12V	<table border="1"> <tr><td>1</td><td>3</td><td>5</td><td>7</td><td>9</td><td>11</td></tr> <tr><td>□</td><td>□</td><td>■</td><td>□</td><td>□</td><td>□</td></tr> <tr><td>□</td><td>□</td><td>■</td><td>□</td><td>□</td><td>□</td></tr> <tr><td>2</td><td>4</td><td>6</td><td>8</td><td>10</td><td>12</td></tr> </table>	1	3	5	7	9	11	□	□	■	□	□	□	□	□	■	□	□	□	2	4	6	8	10	12	
1	3	5	7	9	11																					
□	□	■	□	□	□																					
□	□	■	□	□	□																					
2	4	6	8	10	12																					
COM4 Pin10	RI	<table border="1"> <tr><td>1</td><td>3</td><td>5</td><td>7</td><td>9</td><td>11</td></tr> <tr><td>□</td><td>□</td><td>□</td><td>■</td><td>□</td><td>□</td></tr> <tr><td>□</td><td>□</td><td>□</td><td>■</td><td>□</td><td>□</td></tr> <tr><td>2</td><td>4</td><td>6</td><td>8</td><td>10</td><td>12</td></tr> </table>	1	3	5	7	9	11	□	□	□	■	□	□	□	□	□	■	□	□	2	4	6	8	10	12
	1	3	5	7	9	11																				
	□	□	□	■	□	□																				
□	□	□	■	□	□																					
2	4	6	8	10	12																					
+5V	<table border="1"> <tr><td>1</td><td>3</td><td>5</td><td>7</td><td>9</td><td>11</td></tr> <tr><td>□</td><td>□</td><td>□</td><td>□</td><td>■</td><td>□</td></tr> <tr><td>□</td><td>□</td><td>□</td><td>□</td><td>■</td><td>□</td></tr> <tr><td>2</td><td>4</td><td>6</td><td>8</td><td>10</td><td>12</td></tr> </table>	1	3	5	7	9	11	□	□	□	□	■	□	□	□	□	□	■	□	2	4	6	8	10	12	
1	3	5	7	9	11																					
□	□	□	□	■	□																					
□	□	□	□	■	□																					
2	4	6	8	10	12																					
▲+12V	<table border="1"> <tr><td>1</td><td>3</td><td>5</td><td>7</td><td>9</td><td>11</td></tr> <tr><td>□</td><td>□</td><td>□</td><td>□</td><td>□</td><td>■</td></tr> <tr><td>□</td><td>□</td><td>□</td><td>□</td><td>□</td><td>■</td></tr> <tr><td>2</td><td>4</td><td>6</td><td>8</td><td>10</td><td>12</td></tr> </table>	1	3	5	7	9	11	□	□	□	□	□	■	□	□	□	□	□	■	2	4	6	8	10	12	
1	3	5	7	9	11																					
□	□	□	□	□	■																					
□	□	□	□	□	■																					
2	4	6	8	10	12																					

VGA Power Settings

Function	JP9 (1-2)		
▲ No Power	<table border="1"> <tr><td>□</td></tr> <tr><td>□</td></tr> </table>	□	□
□			
□			
+12V	<table border="1"> <tr><td>■</td></tr> <tr><td>□</td></tr> </table>	■	□
■			
□			

▲ = Manufacturer Default Setting



OPEN



SHORT

LCD ID Settings

Panel Number	Resolution			LVDS		JP3																				
				Bits	Channel	(1-2) (3-4) (5-6) (7-8)																				
1	1024	x	768	24	Single	<table style="border-collapse: collapse; text-align: center;"> <tr><td></td><td>1</td><td>3</td><td>5</td><td>7</td></tr> <tr><td>□</td><td>□</td><td>■</td><td>■</td><td></td></tr> <tr><td>□</td><td>□</td><td>■</td><td>■</td><td></td></tr> <tr><td></td><td>2</td><td>4</td><td>6</td><td>8</td></tr> </table>		1	3	5	7	□	□	■	■		□	□	■	■			2	4	6	8
	1	3	5	7																						
□	□	■	■																							
□	□	■	■																							
	2	4	6	8																						
2	1280	x	1024	24	Dual	<table style="border-collapse: collapse; text-align: center;"> <tr><td></td><td>1</td><td>3</td><td>5</td><td>7</td></tr> <tr><td>□</td><td>□</td><td>■</td><td>□</td><td></td></tr> <tr><td>□</td><td>□</td><td>■</td><td>□</td><td></td></tr> <tr><td></td><td>2</td><td>4</td><td>6</td><td>8</td></tr> </table>		1	3	5	7	□	□	■	□		□	□	■	□			2	4	6	8
	1	3	5	7																						
□	□	■	□																							
□	□	■	□																							
	2	4	6	8																						
3	800	x	600	18	Single	<table style="border-collapse: collapse; text-align: center;"> <tr><td></td><td>1</td><td>3</td><td>5</td><td>7</td></tr> <tr><td>□</td><td>□</td><td>□</td><td>■</td><td></td></tr> <tr><td>□</td><td>□</td><td>□</td><td>■</td><td></td></tr> <tr><td></td><td>2</td><td>4</td><td>6</td><td>8</td></tr> </table>		1	3	5	7	□	□	□	■		□	□	□	■			2	4	6	8
	1	3	5	7																						
□	□	□	■																							
□	□	□	■																							
	2	4	6	8																						
4	1024	x	768	18	Single	<table style="border-collapse: collapse; text-align: center;"> <tr><td></td><td>1</td><td>3</td><td>5</td><td>7</td></tr> <tr><td>□</td><td>□</td><td>□</td><td>□</td><td></td></tr> <tr><td>□</td><td>□</td><td>□</td><td>□</td><td></td></tr> <tr><td></td><td>2</td><td>4</td><td>6</td><td>8</td></tr> </table>		1	3	5	7	□	□	□	□		□	□	□	□			2	4	6	8
	1	3	5	7																						
□	□	□	□																							
□	□	□	□																							
	2	4	6	8																						

▲ = Manufacturer Default Setting



OPEN



SHORT

Appendix

Drivers Installation:

The shipping package includes a Driver CD. You can find every individual driver and utility that enables you to install the drivers in the Driver CD.

Please insert the Driver CD into the drive and double click on the “index.htm” to pick up the models. You can refer to the drivers installation guide for each driver in the “Driver/Manual List”.